

GP Batteries

DATA SHEET

NO MERCURY ADDED

Description	Mercury & Cadmium Free Alkaline Manganese Battery, AA Size
Chemical System	Alkaline Manganese
Nominal Voltage	1.5 Volts
Nominal Dimensions	Refer to drawing
Terminals	Protruded positive (+) and flat negative (-) contacts
Jacket	Foil jacket
Applications	All electronic devices, e.g. toys, photographic equipment, data banks, calculators, audio appliances, remote controls, paging machines.
Ambient Temperature Range	Operation: -18°C ~ 50°C Recommended: 10°C ~ 25°C Storage: Not exceed 30°C
Shelf Life	5 years
Approx. Weight	23g

Cross References:

GP	JIS	IEC	Energizer	Duracell
15AX	LR6	LR6	E91	MN1500

Discharge curve:

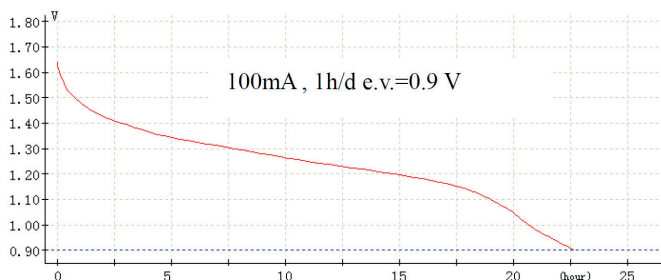
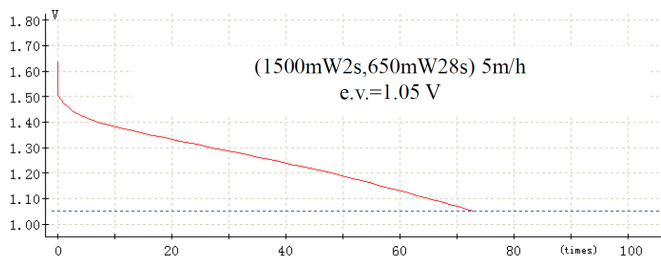

Remarks

- 1) Store period before test shall be under 20±2°C, RH 55±20% within 30 days of manufacture.
- 2) Batteries shall not leak during the service life test before the end voltage reached.

www.gpbatteries.com

Manufacturer reserves the right to alter or amend the design, model and specification without prior notice.
Copyright© GPI International Ltd. - All rights reserved



Model No.: **GP15AX**

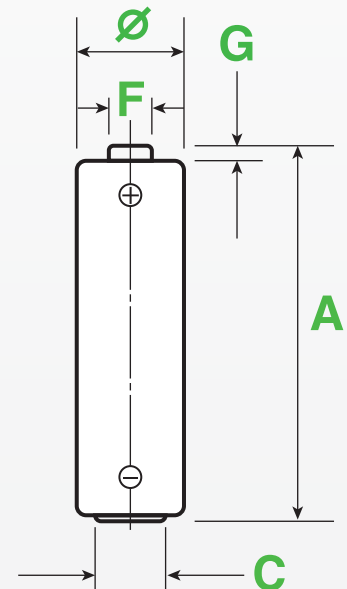

/	min	max
Ø	13.7	14.5
A	49.5	50.5
C	7.0	—
F	—	5.5
G	1.0	—

Dimension : mm

The information (subject to change without prior notice) contained in this document is for reference only and should not be used as a basis for product guarantee or warranty. For applications other than those described here, please consult your nearest GP Sales and Marketing Office or Distributors.

Member
Gold Peak Technology Group